

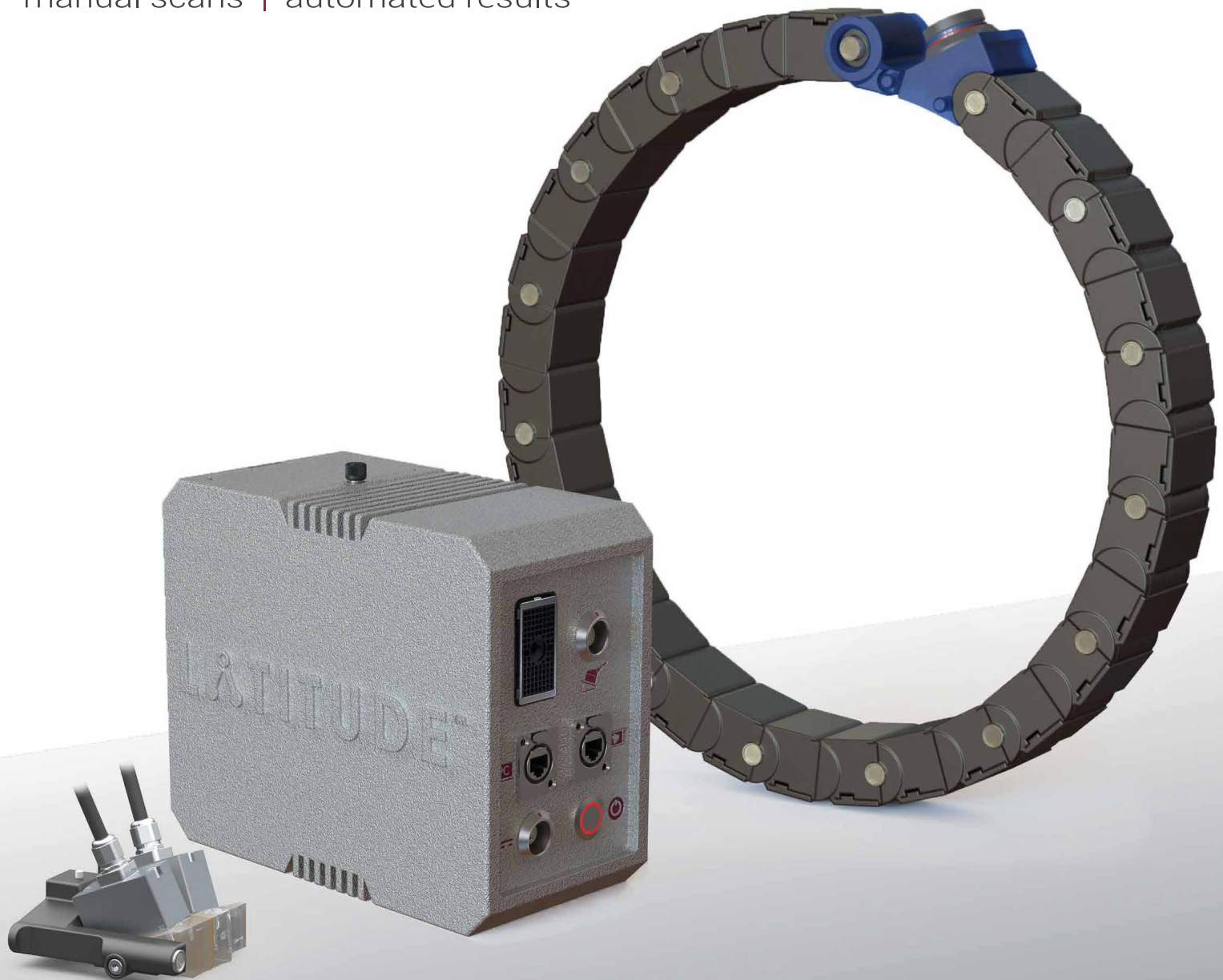

LATITUDE™

manual scans | automated results



In partnership with



Structural Integrity
Associates, Inc.®

CHANGING HOW NDE DATA IS ACQUIRED

Structural Integrity Associates, Inc. (SI) has recently developed LATITUDE™, a revolutionary non-mechanized position and orientation encoding system designed for use with nondestructive examination (NDE) equipment, enabling an operator to collect high-quality encoded data using a manual examination procedure. LATITUDE is a fast and compact alternative to cumbersome and complicated automated inspection equipment.

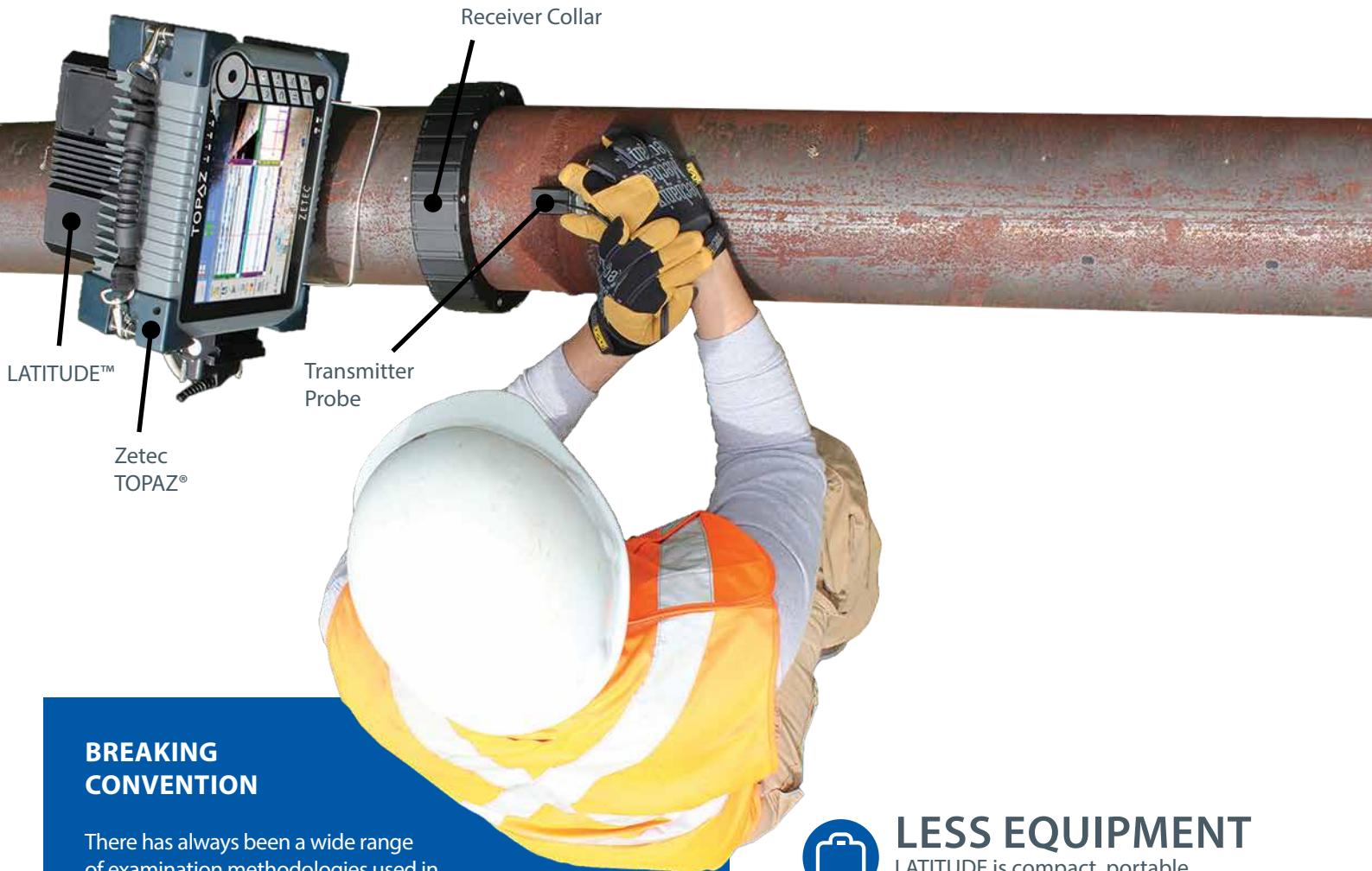

BREAKING CONVENTION

There has always been a wide range of examination methodologies used in industry; a range primarily driven by the economics and availability of technology. On one end of the spectrum, manual NDE examinations are relatively simple, quick, and do not require any ancillary equipment; however, there is typically no detailed digital record of the NDE data created, meaning that the NDE data is not available for secondary analysis or future reference. On the other end of the spectrum, fully automated NDE provides a detailed digital record of the examination that can be reviewed and digitally stored for future reference and comparatively, the data acquisition process is much more complicated, requires much more specialized equipment, the overall examination process typically takes much longer, and is more expensive. LATITUDE combines the simplicity of a manual inspection with the rigor and quality of an automated inspection, delivering unmatched inspection value.



LESS EQUIPMENT

LATITUDE is compact, portable, and battery powered



SMALLER CREW

LATITUDE is designed to be set up and operated by a single person



FASTER SETUP

LATITUDE adds minimal set-up time to that required for a traditional manual examination



BETTER QUALITY

LATITUDE guarantees coverage and puts the probe back into a human hand, helping to optimize coupling and indication response

HOW IT WORKS

LATITUDE uses air-borne ultrasound to achieve its position tracking capabilities and does so by tracking the position of a small transmitting probe relative to a set, or array, of stationary receiver sensors. The LATITUDE transmitting probe can be attached to a variety of NDE probes and the absolute position of the NDE probe can be tracked multi-dimensionally, relative to the receiver array. Currently, the LATITUDE system can track x (axial) position, y (circumferential) position, probe rotation (skew), and can compensate for pipe (or component) curvature.

The LATITUDE system consists of three primary components: ❶ the electronic control unit, ❷ the receiver array, and ❸ the transmitter probe attachment. In Phased Array Ultrasonic Testing (PAUT), the electronic control is integrated with the Zetec TOPAZ® PAUT instrument and control of the LATITUDE system is done through the customized TOPAZ user interface. The LATITUDE enclosure is sealed, fanless, and can run for up to 10 hours off two hot-swappable batteries, eliminating the need for a 120V power supply.

Installing and calibrating the LATITUDE system adds minimal set-up time to that required for a traditional manual examination. LATITUDE has been extensively tested in the laboratory and in a power plant environment and has been demonstrated to be resilient in the presence of acoustic and electromagnetic noise.

1



LATITUDE CONTROL UNIT

The LATITUDE electronic control unit is the brain of the system, responsible for collecting the air-borne ultrasonic data, translating it into position information, and communicating with the NDE data acquisition system. It consists of a sealed fanless enclosure and is powered by two (2) hot-swappable batteries that provide ~10 hours of usage. The LATITUDE control unit can be attached to the rear of a PAUT instrument using a quick-release clip.

2



RECEIVER ARRAY

The LATITUDE receiver array consists of a conformable self-aligning collar for use on flat and curved surfaces. Depending on the application, the collar can be wrapped around the pipe circumference, stretched along the pipe axis, or be otherwise placed on any flat or curving surface. All wiring is self-contained and there is a single connection point to the LATITUDE electronics.

3

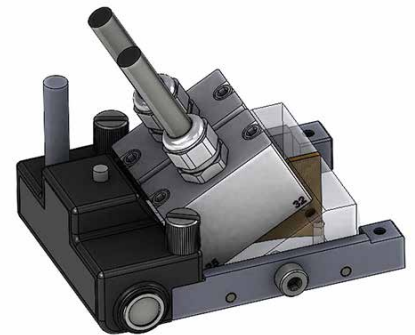

TRANSMITTER ATTACHMENT

The LATITUDE transmitter probe attachment contains multiple sensors for determining the axial (x-) position, circumferential (y-) position, and skew (rotation) of the fixture. It is typically affixed to an NDE sensor that is being used to conduct an examination, such as a PAUT probe, an eddy current testing (ECT) probe, or any of several other kinds of NDE sensors.

APPLICATION NOTE

Section XI, Appendix VIII, Supplement 10 - Dissimilar Metal Weld Examinations

In nuclear power plants, Section XI Encoded PAUT examinations have required the use of robotic scanner mechanisms to provide encoded positional information that, when combined with the corresponding UT data, can be used to produce 3D images that allow quantitative examinations; however, these automated UT (AUT) examinations are costly and sometimes pose accessibility challenges. In addition, these systems require additional personnel and higher degrees of mechanical aptitude to implement and inspection time can be significant.

Specifically for Section XI PAUT examinations of dissimilar metal welds, LATITUDE provides the information of an AUT examination with the simplicity of a manual examination. SI recently qualified an innovative PAUT procedure for use in examining dissimilar metal welds using LATITUDE that uses a detection-only approach. The procedure qualification was administered by the Electric Power Research Institute (EPRI) in accordance with the rigorous demands of the ASME Code Section XI, Appendix VIII and the Performance Demonstration Initiative (PDI) requirements. The combined benefits of using LATITUDE with the recently qualified UT procedure include the following:

- Significantly reduces the average time spent per inspection location

- Reduces the number of personnel required for scanning and data acquisition
- Drastically reduces the amount of equipment needed for examinations
- Manual manipulation of the PAUT probe allows operator to ensure good coupling of the probe and optimize indication responses on-the-fly
- Portability and compactness allows quick setup and breakdown when moving between inspection locations
- Smaller footprint that increases accessibility and reduces pre-examination preparations
- Battery power eliminates the need for a 120V power source

The images below show a comparison of PAUT data collected using LATITUDE (left) and using a typical AUT setup (right). Both data sets were acquired on the same component with the same probe configuration and show the same two circumferential flaws. As seen from the displayed data, the encoding capability of the LATITUDE system is virtually indistinguishable from that of the AUT system, a testament to the encoding resolution and accuracy that can be achieved with LATITUDE. Furthermore, the observed signal-to-noise ratio of the 20% through-wall indication is noticeably improved in the LATITUDE data set; a demonstration of the improved fidelity that can be achieved with a manual examination.

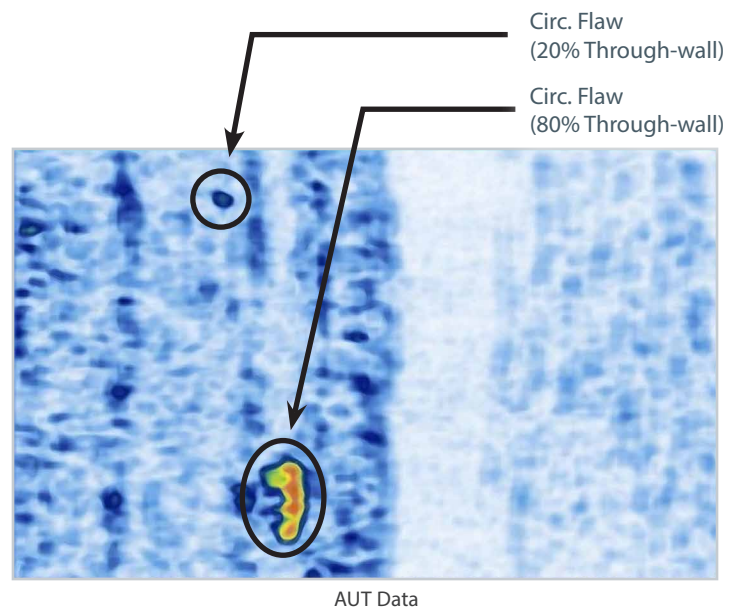
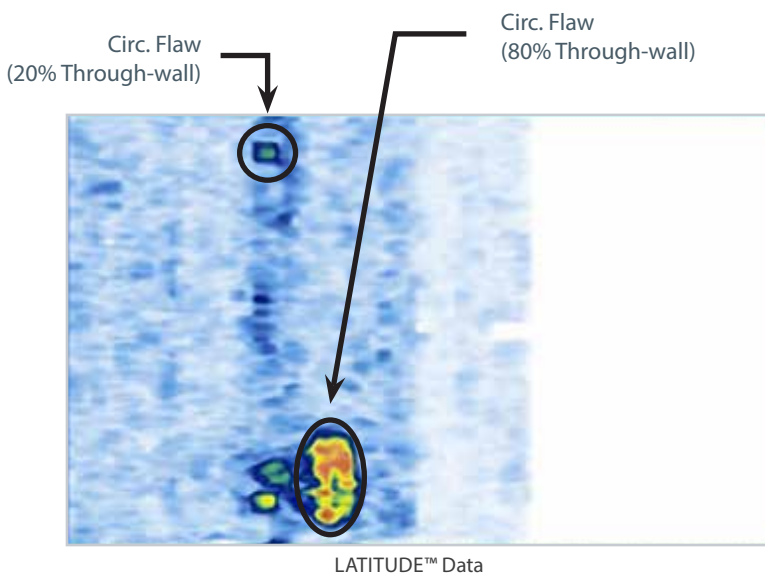

APPLICATION NOTE

Fabrication Acceptance Examinations

Radiographic testing (RT) of welds during fabrication or in-service examinations come with a risk of radiation exposure and usually result in personnel access restrictions, leading to work stoppages and, ultimately, to increases in task and possibly outage durations. In addition, detection and accurate sizing of certain flaw types based on location and geometry can be difficult with RT. For these reasons, UT has been investigated and demonstrated to be an effective replacement for RT when the UT examinations meet specific requirements. These requirements are specified in ASME code cases, including Section III and XI, B31.1, and B31.3 and, among other things, include the use of equipment that can record the UT data, including the scanning positions. Therefore, AUT systems have typically been deployed for these examinations.

As mentioned previously, AUT examinations can be costly, sometimes pose accessibility challenges, and often require additional personnel to implement, leading to potentially significant inspection times and costs. UT in lieu of RT examinations, therefore, represent another opportunity where LATITUDE can be deployed to provide the same information as an AUT examination with the simplicity of a manual examination, potentially significantly reducing inspection time and cost. The following benefits are again realized for UT in lieu of RT weld examinations:

- Significantly reduces the average time spent per inspection location
- Reduces the number of personnel required for scanning and data acquisition
- Drastically reduces the amount of equipment needed for examinations (faster setup/teardown, easier transport, reduced shipping and equipment costs)
- Manual manipulation of the PAUT probe allows operator to ensure good coupling of the probe and optimize indication responses on-the-fly
- Portability and compactness allows quick setup and breakdown when moving between inspection locations
- Battery power eliminates the need for a 120V power source

The two data sets below show examples where LATITUDE was used to encode PAUT data for a UT in lieu of RT application. The figure on the left shows the PAUT results from a root crack indication and the figure on the right shows the results from a lack-of-fusion-indication. Again, the demonstrated encoding capabilities are comparable to what would be expected from an AUT system, despite the data being collected manually.

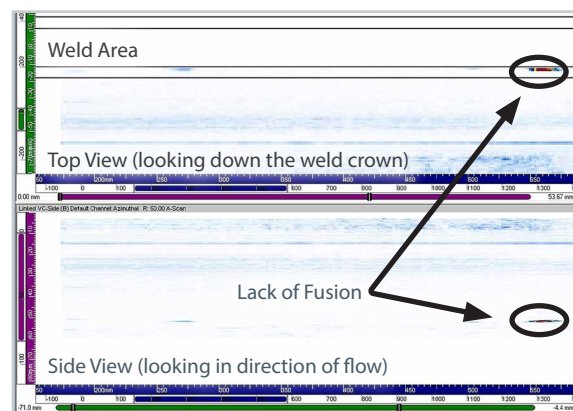
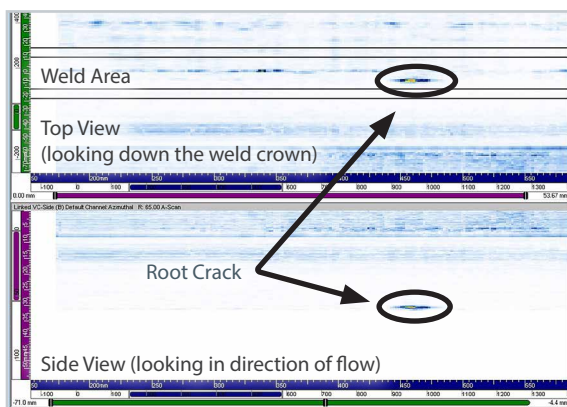
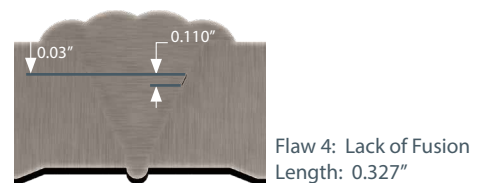
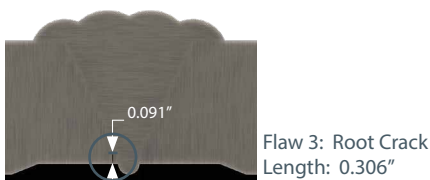

APPLICATION NOTE

Internal Corrosion Mapping

Be it general, flow-accelerated, microbiologically induced, erosion-corrosion or of another form, internal corrosion of piping and pressure vessels is a significant issue across all industries. Often, UT thickness testing is completed manually with the only record of the examination being a report listing the nominal wall thickness and the minimum thickness measured. Adjacent areas that may have less overall wall loss from corrosion can potentially go undocumented. In other applications, UT thickness testing may be completed using a relatively coarse grid over a large area, resulting in a sampling of thickness

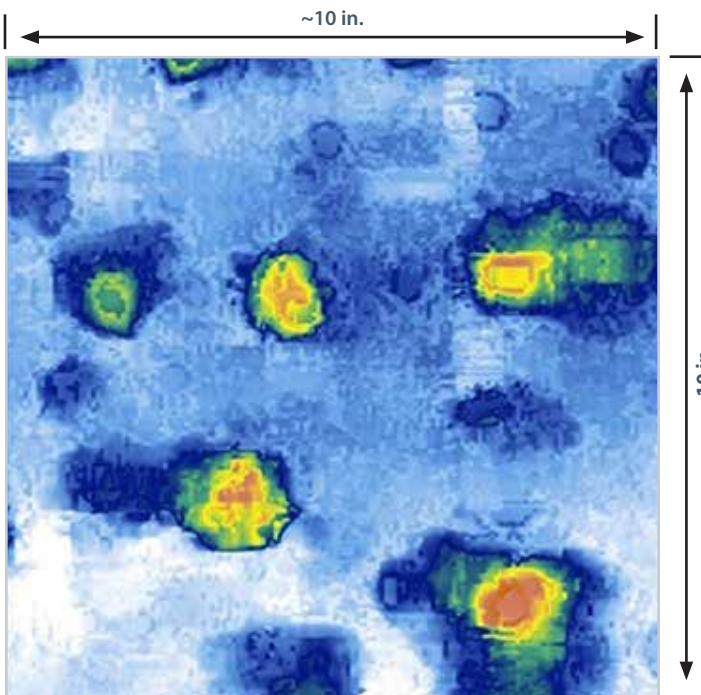

measurements that is far from a map of the actual internal topology of the pipe.

In more critical applications and where higher resolution thickness data is required, AUT systems for thickness mapping are typically employed. These AUT thickness mapping solutions have the same inherent challenges as the AUT equipment used in other applications; the equipment can be complex and pose access limitations, they may require additional personnel to implement, and the inspection time and costs can be significant. Other encoding options that are simpler than fully automated systems can require a significant amount of post-processing time to create composite topographical thickness maps.

LATITUDE, coupled with the use of a PAUT corrosion mapping probe, enables the encoding of high-resolution thickness data while manually manipulating the inspection probe, resulting in a composite thickness map that requires little to no post-processing for analysis. The figure to the left shows an example of a thickness map generated using LATITUDE with a corrosion array probe on a section of service water piping with severe internal corrosion pitting. The scanned area shown is an ~10 in. square, contains upwards of 30,000 discrete UT measurements, and was acquired in less than 2 minutes of scanning. Furthermore, the data files created using this approach can be imported into finite-element analysis (FEA) software to perform engineering analyses of the component with wall loss. The advantages of the LATITUDE encoded corrosion mapping approach are as follows:

- Provides high-resolution encoded thickness data using a manual inspection approach
- Fully characterizes the internal surface condition of the component (i.e., no sparse sampling)
- Digital thickness map can be used in FEA software to conduct engineering analyses of the component
- Requires fewer people and less hardware than traditional fully automated corrosion mapping solutions
- Manual manipulation of the PAUT probe allows the operator to ensure good coupling of the probe and optimize indication responses on-the-fly
- Portability and compactness allows quick setup and breakdown when moving between inspection locations
- Battery power eliminates the need for a 120V power source

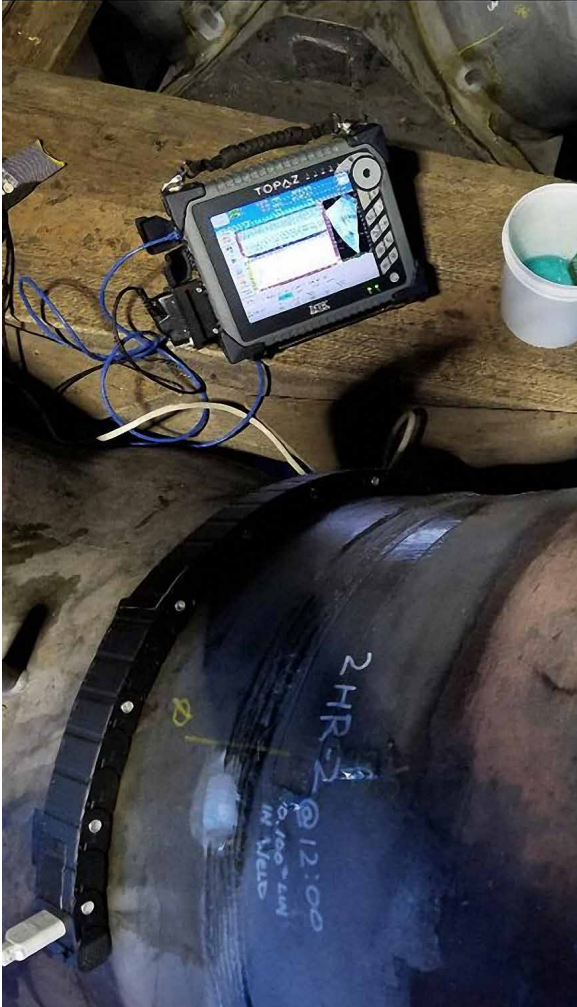

APPLICATION NOTE

Generic Weld Examinations

With potential exposure to high stresses, extreme operating environments, and harsh contents, weldments are among the most susceptible regions of piping and pressure vessels and can have significant consequences in the event of catastrophic failure. Ultrasonic testing and other NDE methods are commonly deployed to examine girth, seam, and other weld configurations for the presence of fabrication and service induced flaws. Depending on the component geometry, application, inspection procedure, and other factors, many NDE weld examinations are conducted manually, without a digital data record.

LATITUDE presents a new opportunity to encode manual examinations of weldments where the use of automated or other mechanical encoding methods are impractical or cost prohibitive. It has been used for the examination of girth and seam welds and can be deployed with phased-array UT (PAUT), time-of-flight-diffraction (TOFD), and a range of other NDE technologies. LATITUDE encoded manual inspections provide proof of coverage and a digital record of the examination data at a fraction of the cost of typical automated or robotic examinations. Furthermore, LATITUDE is compact, portable, and battery powered, minimizing the amount of equipment that needs to be transported between weld inspection locations.

The photograph on the left is from a LATITUDE encoded PAUT inspection of a high-energy pipe girth weld at a fossil power station. The image below shows a screenshot of the encoded data from the examination. Multiple fabrication flaws are evident in the data.

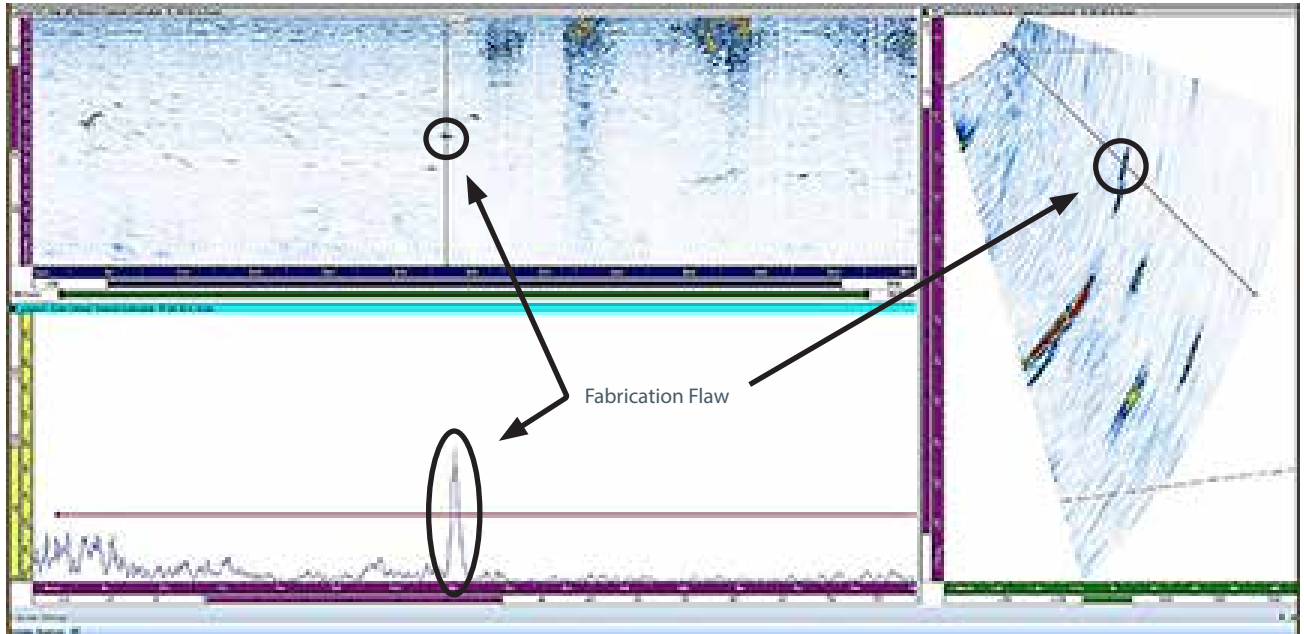

LATITUDE SPECIFICATION

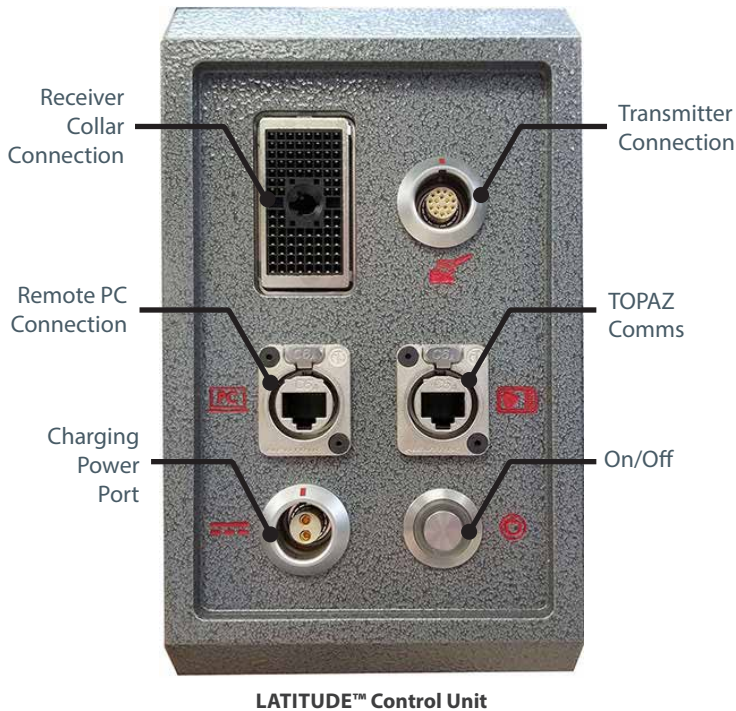

Instrument

Dimensions	9.25 x 7.5 x 4.5 in (235 x 190 x 115 mm)
Weight	13.5 lbs (6.1 kg)
Power Requirements	100-240VAC, 50/60Hz
Power Supply	Direct VAC or Battery
Battery Type	Li-ion, 98Wh
Battery Life	10 hrs. typ., Hot Swappable
Cooling	Sealed, Fanless
Connectivity	Ethernet

Performance

X-Axis (Axial) Resolution	0.05 in (1.3 mm)
X-Axis (Axial) Position Accuracy	± 0.150 in (± 3.8 mm)
Y-Axis (Circ.) Resolution	0.05 in (1.3 mm)
Y-Axis (Cir.) Position Accuracy	± 0.150 in (± 3.8 mm)
Skew Resolution	1°
Skew Accuracy	± 3°
X-Axis (Axial) Scan Range ¹	4-12 in (100-300 mm)
Y-Axis (Circ.) Scan Range ²	70 in (1.80 m)
Max. Scan Speed	2 in/s (50 mm/s)
Diameter Range ³	6 in (150 mm) to Flat

Environmental

Radial Clearance	1.25 in (32 mm)
Axial Clearance ⁴	5.5 in (140 mm)

¹ Represents the range over which the specified position accuracy and resolution apply. Scanning beyond this range is possible though measurement errors may exceed this specification.

² Y-axis scan range is based on the length of the receiver collar being used. Currently, the longest available collar can cover an ~70 inch range.

³ Though the system will operate on smaller diameters, adherence to the performance specification has not been verified for pipe diameters less than 6 inches.

⁴ Represents the distance between the back side of the receiver array collar and the beginning of the scan range. Actual collar width is ~1.5 inches.

The information presented in this document is accurate as of the date of publication. All images and photographs presented herein are representative and actual products may differ. Structural Integrity Associates reserves the right to change product information, offerings, and specifications without prior notification.



Zetec, Inc.
8226 Bracken Pl. SE, Suite 100
Snoqualmie, WA 98065
Toll Free: 800.643.1771
P: 425.974.2700
www.zetec.com
marketing@zetec.com



Structural Integrity Associates
5215 Hellyer Avenue, Suite 210
San Jose, CA 95138
Toll free: 877-4SI-Power
P: 877-474-7693
www.si-latitude.com
info@structint.com